

UNI-T®

UT222

Operating Manual



Certificate No. 956661



2500A Digital Clamp Meters



P/N:110401104248

CONTENTS

I. OVERVIEW-----	1
II. OPEN CASE AND CHECK-----	1
III. SAFETY CODES-----	2
IV. ELECTRICAL SYMBOLS -----	3
V. EXTERNAL STRUCTURE -----	4
VI.LCD DISPLAY -----	5
VII.KEY FUNCTION -----	7
VIII.MEASUREMENT OPERATING INSTRUCTION -----	9
1. DC voltage measurement -----	9
2. AC voltage measurement -----	11
3. Resistance measurement -----	13
4. Circuit on-off measurement-----	15
5. Diode measurement -----	17
6. Capacitance measurement -----	19
7. Frequency/duty ratio measurement -----	21
8. Temperature measurement-----	23
9. DC current measurement -----	25
10.AC current measurement -----	27
11.Current signal output function -----	29
12.Power gear -----	30
13. Automatic shutdown function-----	30
IX. TECHNICAL INDICATOR -----	31
X. MAINTENANCE AND UPKEEP -----	39

I. OVERVIEW

UT222 is a portable true RMS 3-5/6 bit (6000 Counts), auto range clamp ammeter with simulation bar. The clamp ammeter featuring full-function on screen display, full-range overload protection and unique appearance design has become a specific clamp ammeter with superior performance. The clamp ammeter is applicable to following measurements: AC/DC voltage, AC/DC current, surge current, resistance, frequency, maximum/minimum value measurement, relative value measurement, data recording and read-back, under-voltage display and automatic shutdown function.

The instruction manual includes relevant safety information and warning indication, please read them carefully and strictly observes all warnings and notes.

II. OPEN CASE AND CHECK

Unpack and take out the instrument, please check carefully if the following attachment are complete or intact, if any lack or damage were found, please contact with your supplier.

- An operating instruction manual
 - A test pen
 - A temperature sensor
 - A tool box
 - A certificate
- Optional Components:
- Analog output line











III. SAFETY CODES

The clamp ammeter is designed and produced strictly in accordance with IEC61010-1 safety standard. It meets the double insulation over-voltage standard CAT II 1000V, CAT III 600V and safety standards of pollution degree II. If fail to use the meter under the relevant operation Instruction, the protection provided shall be weakened or lost.

1. Check the clamp ammeter and test pen before using, guard against any damage or abnormal phenomenon. If any abnormal condition were found: bare test pen, damaged chassis, no display or random display in LCD, please do not use it. It is forbidden to use the clamp ammeter without rear cap or rear cap not in place, or otherwise there will be electric shocking.
2. Damaged test pen should be replaced with the one of same type or electric specification.
3. Do not contact the bare wire and connector, unused input terminal or the circuit being measured when clamp ammeter is in operation.
4. Be careful in measuring voltage higher than DC 42V or AC 30V and keep finger within the scope of test pen finger protection position to guard against electric shocking.
5. Set the function range switch at the maximum range position if the scope of measured value couldn't be defined.
6. Refrain from applying between terminals or the terminals and grounding the voltage or current over the rating value labeled on the clamp ammeter.
7. Function switches shall be set at the correct position in measurement. Before converting function switches, connection between the table pen measured circuits shall be broken off and gear conversion in measurement shall be prohibited to guard against damage to the meter.

8. Refrain from storing or using the clamp ammeter in the explosive and flammable environment with high temperature, high humidity and strong electromagnetic field.
9. Refrain from changing the internal wiring in the clamp ammeter to guard against damage to the meter and danger.
10. When LCD display shows the icon “”, it is required to replace the battery in time to ensure the measurement accuracy.
11. Power off immediately after measurement. Take out battery when the clamp ammeter will not be in use for a long time.

IV. Electrical symbols

	Dual insulation		Diode
	Grounding		Low battery
	Warning prompt		AC or DC (Alternating current or direct current)
	AC (Alternating current)		Danger! High voltage!
	DC (Direct current)		Comply with EU standard
	Buzzing on-off		

V. EXTERNAL STRUCTURE (SEE FIGURE 1)

1. Clamp ammeter body: Safety design to protect operator from touching the dangerous area.
2. Clamp head pulling handle: Press the trigger to open the clamp head, when release the trigger, clamp head will partially closed.
3. Functional key: Select basic functions.
4. Analog current output
5. Measure input termina: Measure the signal inputl.
6. Toggle:Used to select the measurement of input terminal or analog current output terminal.
7. LCD display area: Display the measurement data and functional symbols.
8. Dial switch: Select the measurement function gear.
9. Clamp head: A device used to measure AC/DC current and covert current into voltage.

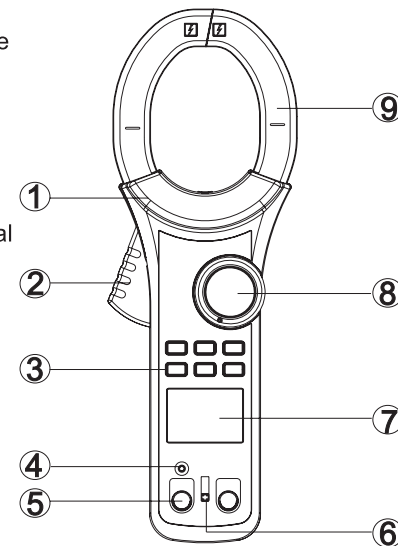
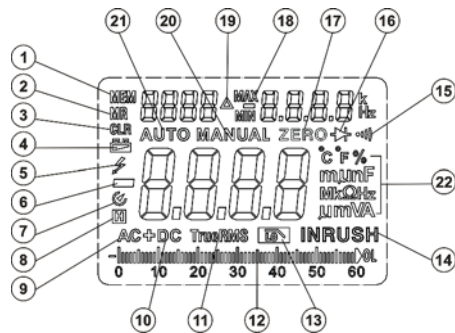

Figure 1

VI. LCD DISPLAY (SEE FIGURE 2)



1.MEM:	Memory number prompt
2.MR	Read back stored data prompt
3.CLR	Stored data clearing prompt
4.	Battery under-voltage prompt
5.	High voltage warning prompt
6.	Display negative reading
7.	Auto shutdown prompt
8.	Hold mode prompt

9.AC	AC measurement prompt	
10.DC	DC measurement prompt	
11.TrueRMS	TrueRMS measurement prompt	
12.+ system digit and simulation bar	Measurement of reading value	
13.	LPF measurement prompt	
14.INRUSH	INRUSH current measurement prompt	
15.	Buzzing on-off measurement prompt	
16.	Diode measurement prompt	
17.ZERO	AC current gear ZERO prompt	
18.MAX、MIN	Maximum and minimum value measurement prompt	
19.	Relative measurement prompt	
20.Manual	Manual range prompt	
21.Auto	Auto range prompt	
22.Measurement unit:	V	Voltage unit: Volt
	A	Current unit: Ampere
	Ω , k Ω , M Ω	Resistance unit: Ω ,k Ω ,M Ω
	nF, μ F, mF	Capacitance unit:nF, μ F,mF
	Hz, kHz, MHz	Frequency unit:Hz,kHz,Mhz
$^{\circ}$ C, $^{\circ}$ F	Temperature unit: $^{\circ}$ C, $^{\circ}$ F	

VII. KEY FUNCTION (SEE FIGURE 3)



1. SELECT/CLEAR

It is able to select gear by a short press.

With a long press, LCD will display “CLR” symbol, clear stored data record, and then “CLR” symbol disappears, MEM stored number becomes 0.

2. RANGE/▲

Under the non-read back storage of record data mode, enter the manual measurement mode by a short press on RANGE and change the range. After a long press on RANGE, manual range will turn to auto range.

Under the read back storage record data mode, it is able to read back the upward data by pressing the key.

3. MAX/MIN/STORE

With a press on the key, enter MAX/MIN standby mode, LCD will display “— — — —” ; after the second press, LCD will display “MAX” to enter the maximum value measurement mode, after

the third press, LCD will display “MIN” to enter the minimum value measurement mode. Under non-standby mode, it is able to record the current measurement data with a long press on the key.

4. REL/▲

With the exception of DC current gear, under the non-read back stored record data mode, it is able to enter the relative measurement mode with a short press, the main display will show: measured value-basic value, the right display: basic value, after another press, quit the mode. Under the DC gear measurement mode, enter the clearing mode with a short press, LCD will display “ZERO” .

Under the non-read back stored record data mode, it is able to enter the continuous recording data mode, after another long press, quit the mode.

Under the read back stored recording data mode, it is able to read back the recorded data backward by pressing the key.

5. INRSUH/LOAD

At the AC current gear, it is able to enter INRUSH current measurement mode by pressing the key, after another pressing, quit the mode.

After long press on the key, enter the read back stored recording data mode, after another press on the key, quit the mode.

6. HOLD/☀

After a short press, enter the reading hold measurement mode, after another press, quit the mode. After a long press, the backlight will be illuminated, in case of long press within 10s, backlight will be out, and if no long press, it will be automatically out after 10s.

VIII. MEASUREMENT OPERATING INSTRUCTION

1. DC voltage measurement (See Figure 4)

- 1) Insert red test pen in “V” jack and black test pen in “COM” jack.
- 2) Push the function range switch to the DC voltage measurement gear, and connect test pen in parallel with the power or load to be measured.
- 3) Directly read the measured voltage value from display.
- 4) Press SELECT at the DC voltage measurement gear to select AC+DC measurement.

⚠ Note:

- Do not input voltage higher than 1000V. It may be feasible to measure higher voltage, but damage will be caused to the meter.
- Watch out for electricity shocking when measuring high voltage.
- After completing all measurement operations, disconnect test pen from the measured circuit.
- When measured voltage is higher than the safety voltage 42V/DC, the meter LC displays high voltage warning prompt “⚡”; when inputting overvoltage, higher than DC 1000V gear range, the meter ⚡ will automatically sound intermittent buzzing and high voltage warning prompt will automatically flash to provide warning prompt.

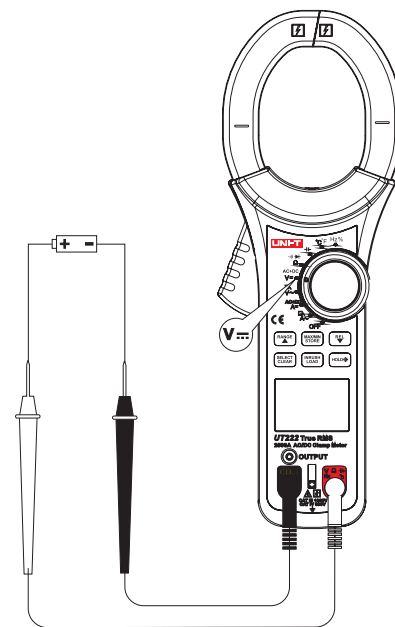

Figure 4

2. AC voltage measurement (See Figure 5)

- 1) Insert red test pen in “V” jack and black test pen in “COM” jack.
- 2) Push the function range switch to the DC voltage measurement gear, and connect test pen in parallel with the power or load to be measured.
- 3) Main display will show the true RMS, while the right secondary display shows frequency value.
Conditions must be met when reading frequency value: input range \geq range \times 10%.
- 4) Press SELECT at the AC voltage measurement gear to select LPF measurement $\overline{\sim}$.

⚠ Note:

- Pay attention to the electric shock in measuring high voltage.
- After completing all measurement operations, disconnect test pen from the measured circuit.
- When measured voltage is higher than the safety voltage 30V/AC, the meter LC displays high voltage warning prompt “⚡”; when inputting overvoltage, higher than AC 1000V gear range, The meter will automatically sound intermittent buzzing and high voltage warning prompt will ⚡ automatically flash to provide warning prompt.
- AC conversion adopts the AC coupling true RMS response mode, sinusoidal input for correction.
The accuracy of non-sinusoidal wave shall be adjusted as follows:

Crest factor 1.4~2.0, accuracy should be increased 1.0%;

Crest factor 2.0~2.5, accuracy should be increased 2.5%;

Crest factor 2.5~3.0, accuracy should be increased 4.0%;

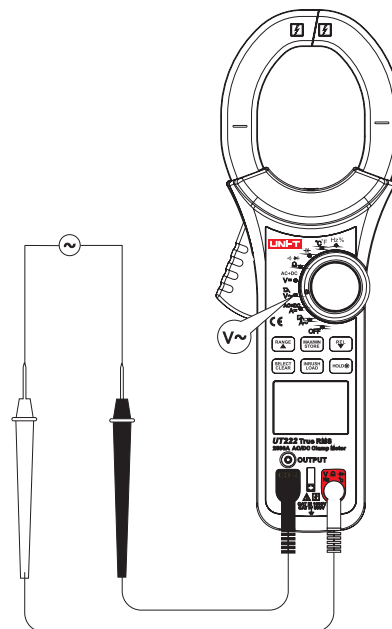

Figure 5

3. Resistance measurement (See Figure 6)

- 1) Insert red test pen in “ Ω ” jack and black test pen in “COM” jack.
- 2) Push the function range switch to the measurement gear “ Ω ” press SELECT to select resistance measurement Ω and connect test pen in parallel with the two terminals of measured resistance .
- 3) Directly read the measured resistance value from display.

⚠ Note:

- If the resistance open circuit or resistance being measured exceeds the maximum range of the meter, display will show “OL” .
- Before measuring resistance on-line, the power of circuits being measured shall be powered off and all capacitors shall release out residues of electric charges to assure the measurement accuracy.
- When measuring low resistance, a measurement error of $0.1\ \Omega \sim 0.2\ \Omega$ will be caused to the test pen, to acquire the accurate reading, it is able to utilize the relative measurement function, input test pen under short-circuit condition, press the \blacktriangle , carry out low resistance measurement after the meter automatically deducts the test pen displayed value under short-circuit condition.
- If the resistance value is not less than $0.5\ \Omega$ when table pen is short circuited, please inspect test pen for loosening or other reasons.
- In measuring resistance over $1M\ \Omega$, it might take several seconds to stabilize the reading, it is normal for high resistance measurement. To acquire stable reading, the test short line can be used for measurement.
- Do not input voltage higher than DC 42V or AC 30V, which may cause personal injury.
- After completing all measurement operations, disconnect the test pen from the circuit being Measured.

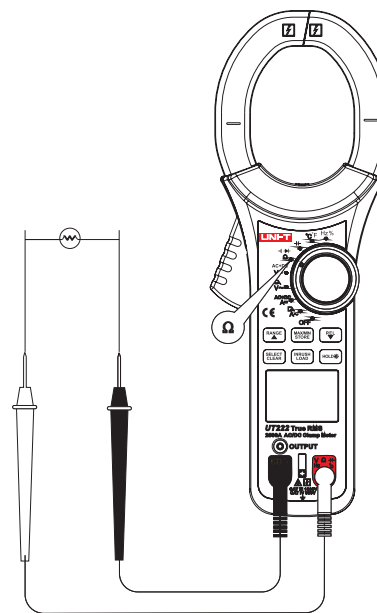

Figure 6

4. Circuit on-off measurement •)) (See Figure 7)

- 1) Insert red test pen in “ Ω ” jack and black test pen in “COM” jack.
- 2) Push the function range switch to the measurement gear “ Ω •))” , press SELECT to select circuit on-off measurement and connect test pen in parallel with the two terminals of measured circuit. When the measured resistance between two terminals $<30\Omega$, the circuit should be deemed conductive, buzzer will sound continuously. When resistance is $\geq 30\Omega$, the buzzer will not sound.
- 3) Directly read the measured resistance value loaded by the circuit from display.

⚠ Note:

- When checking on-line circuit on-off condition, it is required, prior to measurement, to power off all powers in the measured circuit, and discharges all residual charges in the capacitor.
- With respect to the circuit on-off measurement, open-circuit voltage is approximately -3.5V and range should be 600 Ω measurement gear
- Do not input voltage higher than DC 42V or AC 30V, which may cause personal injury.
- After completing all measurement operations, disconnect the test pen from the measured circuit.

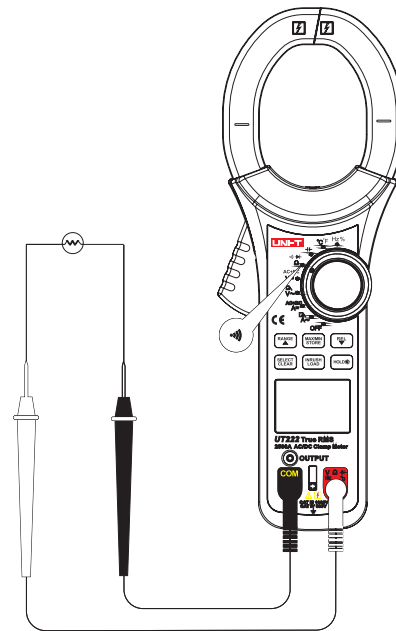

Figure 7

5. Diode measurement \rightarrow (See Figure 8)

- 1) Insert red test pen in “ \rightarrow ” jack and black test pen in “COM” jack. Polarity of red and black test pen is respectively “+” and “-” .
- 2) Push the function range switch to the measurement gear “ Ω \rightarrow \rightarrow ”, press SELECT to select diode measurement and \rightarrow directly read out the approximate forward direction PN junction voltage.

For silicon PN junction, generally 500~800mV is confirmed to be the normal value.

Note:

- “OL” will be displayed when the measured diode is open-circuit or polarity is inversely connected.
- Before measuring diode, the power of circuits being measured shall be powered off and all capacitors shall release out residues of electric charges to assure the measurement accuracy.
- The test open-circuit voltage of diode is approximately 3.5V.
- Do not input voltage higher than DC 42V or AC 30V, which may cause personal injury.
- After completing all measurement operations, disconnect the test pen from the measured circuit.

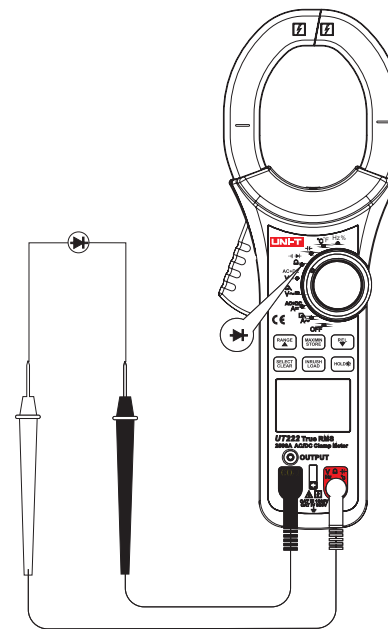

Figure 8

6. Capacitance measurement (See Figure 9)

- 1) Insert red test pen in “ $\overleftarrow{+}$ ” jack and black test pen in “COM” jack.
- 2) Push the range switch to the measurement gear “ $\overleftarrow{+}$ ”, connect test pen in parallel with the two terminals of measured capacitance.
- 3) Directly read out the capacitance value of measured circuit from display. It is recommended to carry out capacitance measurement with test short line input, thus reducing the impact caused by distributed capacitance.

⚠ Note:

- If the measured capacitance is short circuited or capacitance exceeds the maximum range of the meter, display will show “OL” .
- Under capacitance measurement mode, simulation bar indicator is forbidden. It will take longer time to achieve the correct reading when measuring capacitance larger than $600 \mu F$.
- To ensure the measurement accuracy, it is recommended to discharge all residual charges in the capacitor before test, then input meter for measurement, which is of particular importance to the capacitor with high voltage. It is required to prevent damage to the meter and personal injury.
- After completing measurement operation, disconnect the test pen from the measured capacitance.

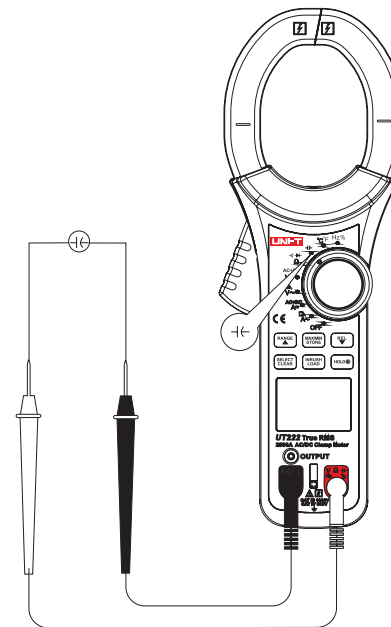

Figure 9

7. Frequency/duty ratio measurement (See Figure 10)

- 1) Insert red test pen in “Hz” jack and black test pen in “COM” jack.
- 2) Push the range switch to the measurement gear “mV $\overline{\sim}$ /Hz%” and press the red key to select Hz function, connect test pen in parallel with the signal source to be measured.
- 3) Directly read out the measured frequency value from display.
- 4) Press SELECT to select duty ratio measurement.

⚠ Note:

- a when measuring:
10Hz~40MHz: $1V_{rms} \leq a \leq 30V_{rms}$ >40MHz: For reference
- Do not input frequency higher than 30V rms, which may cause personal injury.
- After completing all measurement operations, disconnect the test pen from the measured circuit.

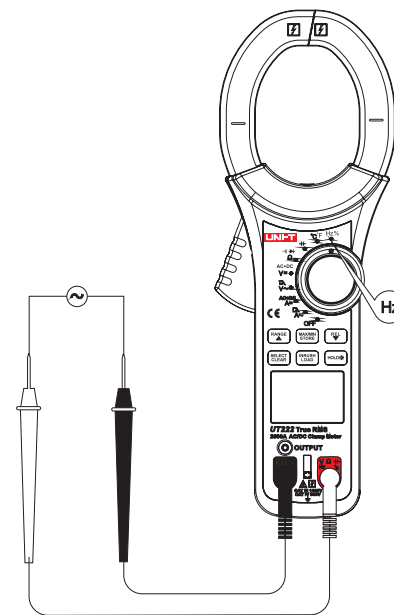

Figure 10

8. Temperature measurement (See Figure 11)

- 1) Push range switch to “ °C / °F ” gear, LCD will display OL, the short-circuit test pen displays the room temperature.
- 2) Insert temperature K type socket in the corresponding hole as per the diagram.
- 3) Put temperature probe detect the measured surface, several seconds later, directly read out the measured Celsius temperature value from LCD.
- 4) Press SELECT to select Fahrenheit temperature measurement.

Note:

- The meter should not be operated in a place with ambient temperature beyond the range 18-28°C, or otherwise measurement error will be resulted, particularly evident in low temperature environment.
- Do not input voltage higher than DC 42V or AC 30V, which may cause personal injury.
- After completing all measurement operations, take off the temperature probe.

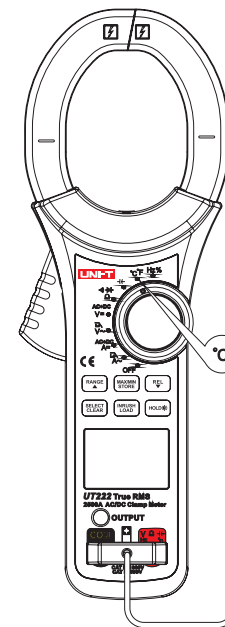

Figure 11

9. DC current measurement (See Figure 12)

- 1) Push the switch to DC current gear A_{DC} , when LCD display is not zero, press REL to clear. After measuring big current gear, clamp head will be left with remanence, and LCD display will have base values.
- 2) Press trigger to open the clamp head to take the conductor to be measured, then slowly loosen the trigger until clamp head is completely closed. Be sure the conductor to be measured is clamped at the center of clamp head, if not, additional error may be resulted, and clamp ammeter can only measure one current conductor, measuring two or more current conductors concurrently may result in wrong measurement reading.
- 3) Directly read out the measured DC current value from display.
- 4) Press SELECT at the DC current gear to select AC+DC measurement.

⚠ Note:

- Current measurement must be operated within $0^{\circ}\text{C} \sim 40^{\circ}\text{C}$, if positive reading is achieved after measuring DC current, the current direction will be from up to down (See Figure 10: the upward is panel and base cap is downward). Do not loosen trigger abruptly, since Hall component is sensitive in some extent to magnet, heat and mechanical stress, but also to the impact, which may cause short-time reading variation.
- Be sure the conductor to be measured is clamped at the center of clamp head, if not, an additional reading error of $\pm 1.0\%$ may be resulted.

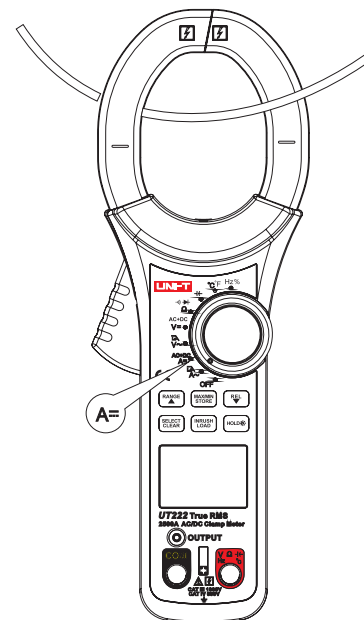

Figure 12

10. AC current measurement (See Figure 13)

- 1) Push the switch to AC current gear $A\sim$, press trigger to open the clamp head to take the conductor to be measured, then slowly loosen the trigger until clamp head is completely closed. Be sure the conductor to be measured is clamped at the center of clamp head, if not, additional error may be resulted, and clamp ammeter can only measure one current conductor, measuring two or more current conductors concurrently may result in wrong measurement reading.
- 2) Main display will show the true RMS, while the right secondary display shows frequency value. Conditions must be met when reading frequency value: input range $\geq \text{range} \times 10\%$.
- 3) Press SELECT at the AC voltage measurement gear to select LPF measurement \overline{f} .
- 4) It is able to press INRUSH at AC current gear to select surge current measurement, clamp ammeter displays "----", indicating it is under standby status for measuring surge current. After starting electrical appliance, the instant-on current of appliance can be measured out; press INRUSH key again to quit the surge current measurement. 600A range can be available for surge current measurement.

⚠ Note:

- Current measurement must be operated within $0^{\circ}\text{C} \sim 40^{\circ}\text{C}$, if positive reading is achieved after measuring DC current, the current direction will be from up to down (See Figure 10: the upward is panel and base cap is downward). Do not loosen trigger abruptly, since Hall component is sensitive in some extent to magnet, heat and mechanical stress, but also to the impact, which may cause short-time reading variation.
- Be sure the conductor to be measured is clamped at the center of clamp head, if not, an additional reading error of $\pm 1.0\%$ may be resulted
- AC conversion adopts the AC coupling true RMS response mode, sinusoidal input for correction. The accuracy of non-sinusoidal wave shall be adjusted as follows:

- Crest factor 1.4~2.0, accuracy should be increased 1.0%;
- Crest factor 2.0~2.5, accuracy should be increased 2.5%;
- Crest factor 2.5~3.0, accuracy should be increased 4.0%;

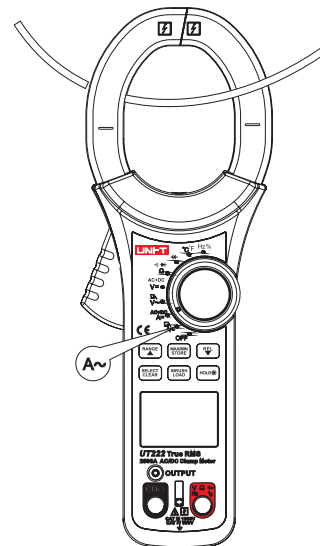

Figure 13

11. Current signal output function (See Figure 14)

UT221 clamp ammeter is provided with the current signal output function, able to convert the measured current signal into voltage signal with the ratio of 1A/1mV and output via the specific output line; by connecting output signal to measurement instrument like the oscilloscope, user can observe the wave form of current signal.

⚠ Note:

Please don't to output port input 5 V above voltage, otherwise, it will lead to instrument internal circuit damage;

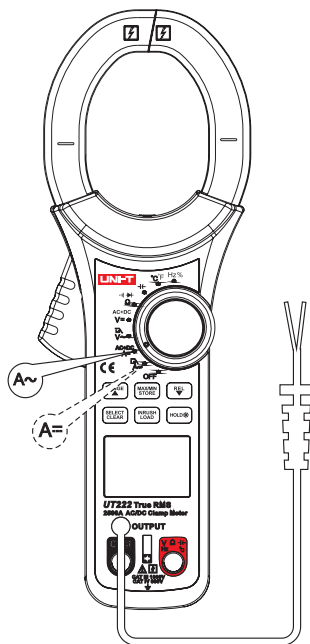

Figure 14

12. Power gear (OFF)

Instrument should be powered off.

13. Automatic shutdown function

If not turning knob switch or pressing key on the clamp ammeter within the user-defined shutdown time (default 15min), display will be blank and enter the low power consumption dormant state. By pressing key or turn the knob switch, the instrument can be wakened up.

⚠ Note:

- Current measurement must be operated within $0^{\circ}\text{C} \sim 40^{\circ}\text{C}$, if positive reading is achieved after measuring DC current, the current direction will be from up to down (See Figure 10: the upward is panel and base cap is downward). Do not loosen trigger abruptly, since Hall component is sensitive in some extent to magnet, heat and mechanical stress, but also to the impact, which may cause short-time reading variation.
- Be sure the conductor to be measured is clamped at the center of clamp head, if not, an additional reading error of $\pm 1.0\%$ may be resulted

IX. TECHNICAL INDICATOR

1. General specification

- Liquid crystal display: 3 5/6 bit liquid crystal display, maximum display 6000.
- Polarity display: auto positive and negative polarity display.
- Overload display: “OL” or “-OL” .
- Low voltage display: “” indicates that batter voltage is lower than working voltage, reminding replacing battery.
- Sampling rate: 3/s
- Type of sensor: Hall effect sensor for DC/AC measurement
- Test position error: an additional reading error of $\pm 1.0\%$ may be resulted when the power to be measured is not clamped at the center of clamp head
- Resistance to impact strength: 1m fall impact
- Maximum openness of clamp head: diameter 63mm
- Maximum size of current lead: diameter 60mm
- Electromagnetic field impact: the application of device near electromagnetic field may result in unstable display or inaccurate reading.
- Power requirement: 6LF22 9V alkaline battery
- Dimension: 298mm×107mm×47mm
- Weight:bout 726g (inclusive of battery);

2. Environment

Indoor

- Maximum height: 2000m
- Safety code: CAT IV 600, CAT III 1000 pollution grade: 2
- Operating humidity and temperature:
0°C~30°C(not bigger than 80%RH), 30°C~40°C (not bigger than 75%RH),
40°C~50°C(not bigger than 45%RH)
- Storage humidity and temperature: -20°C~+60°C (not bigger than 80%RH)

3. Electrical specification

- Accuracy: \pm (%+ word number), one-year calibration time
- Ambient temperature: 23°C \pm 5°C
- Ambient humidity: \leq 80% RH
- Temperature coefficient: 0.1 \times (accuracy) /°C

(1) DC voltage V_{DC}

Range	Resolution	Accuracy: \pm (% reading + word number)
6V	0.001V	$\pm(0.5\%+2)$
60V	0.01V	
600V	0.1V	
1000V	1V	$\pm(1\%+2)$

Input impedance: about 10M Ω

Overload protection: 1000V

(2) AC voltage V_{\sim}

Range	Resolution	Accuracy: \pm (% reading + word number)	
6V	0.001V	40Hz \sim 400Hz	400Hz \sim 1kHz
60V	0.01V	$\pm(1\%+3)$	$\pm(2\%+3)$
600V	0.1V		
1000V	1V	$\pm(1.2\%+3)$	$\pm(2.5\%+3)$

Input impedance: about 10M Ω

Overload protection: 1000V

Display: true RMS, applicable to 10%- 100% of the range.

(3) Voltage AC+DC

Range	Resolution	Accuracy: \pm (% reading + word number)	
6V	0.001V	40Hz \sim 400Hz	400Hz \sim 1kHz
60V	0.01V	$\pm(2\%+20)$	$\pm(4\%+20)$
600V	0.1V		
1000V	1V	$\pm(2.5\%+20)$	$\pm(5\%+20)$

Input impedance: about 10M Ω

Overload protection: 1000V

Display: true RMS, applicable to 10%- 100% of the range.

(4) DC current A_{DC}

Range	Resolution	Accuracy: \pm (% reading + word number)
600A	0.1A	$\pm(1.5\%+5)$
2500A	1A	$\pm(2.5\%+5)$

(5) AC current

Range	Resolution	Accuracy: \pm (% reading + word number)
600A	0.1A	$\pm(1.5\%+5)$
2500A	1A	$\pm(2.5\%+5)$

Display: true RMS, applicable to 10%- 100% of the range.

Frequency response: 50Hz \sim 60Hz

It is normal that the clamp vibrates slightly when measuring 2000 AC current, which however has no impact on measuring accuracy.

(6) Current: AC+DC

Range	Resolution	Accuracy: \pm (% reading + word number)
600A	0.1A	$\pm(3.0\%+20)$
2500A	1A	$\pm(5.0\%+20)$

Display: true RMS, applicable to 10%- 100% of the range.

Frequency response: 50Hz \sim 60Hz

It is normal that the clamp vibrates slightly when measuring 2000 AC current, which however has no impact on measuring accuracy.

(7) Resistance Ω

Range	Resolution	Accuracy: \pm (% reading + word number)
600 Ω	0.1 Ω	Under REL state: $\pm(1.0\%+10)$
6k Ω	0.001k Ω	$\pm(0.6\%+10)$
60k Ω	0.01k Ω	
600k Ω	0.1k Ω	
6M Ω	0.001M Ω	$\pm(1.2\%+2)$
60M Ω	0.01M Ω	$\pm(1.5\%+2)$

Overload protection: 1000V

(8) Continuity test \rightarrow

Range	Resolution	Remark
\rightarrow	0.1 Ω	Open-circuit voltage is about -3.5V; Sound continuity is set as $<30 \Omega$, buzzer continuously sounds. Short circuit is set as $\geq 30 \Omega$, buzzer will not sound.

Overload protection: 1000V

(9) Diode \rightarrow

Range	Resolution	Remark
\rightarrow	0.001V	Open circuit voltage is about 3.5V, able to measure the PN junction $\leq 3V$ forward voltage drop value. The normal voltage value of silicon PN junction is about 0.5~0.8V.

Overload protection: 1000V

(10) Capacitance μ F

Range	Resolution	Accuracy: \pm (% reading + word number)
60nF	0.01nF	Under REL state: $\pm(3\%+5)$
600nF	0.1nF	$\pm(3\%+5)$
6 μ F	0.001 μ F	
60 μ F	0.01 μ F	
600 μ F	0.1 μ F	$\pm(4\%+5)$
6000 μ F	1 μ F	$\pm(5\%+5)$
60mF	0.01mF	Reference value

Overload protection: 1000V

(11) Frequency Hz

Range	Resolution	Accuracy: \pm (% reading + word number)
60Hz	0.001 Hz	$\pm(0.1\%+3)$
600Hz	0.01 Hz	
6kHz	0.0001kHz	
60kHz	0.001kHz	
600kHz	0.01kHz	
6MHz	0.0001MHz	
60MHz	0.001MHz	

Overload protection: 1000V

Input range a: 10Hz~40MHz: $1V_{rms} \leq a \leq 30V_{rms}$;

When >40MHz: unspecified.

(12) Duty ratio %

Range	Resolution	Error limit: \pm (% reading + word number)
10%~90%(10Hz~2kHz)	0.01	\pm (1.2%+30)

Overload protection: 1000V

(13) Temperature

Range	Resolution	Error limit: \pm (% reading + word number)
-40°C~40°C	1°C	\pm (2%+10)
40°C~400°C		\pm (1%+10)
400~1000°C		\pm 2.5%
-40°F~104°F	2°F	\pm (2%+18)
104°F~752°F		\pm (1%+18)
752~1832°F		\pm 2.5%

Overload protection: 1000V

Temperature sensor: K type (Ni-Cr and Ni- Si) thermocouple

(14) AC voltage + LPF

Range	Resolution	Remark
6V	0.001V	Intercept AC voltage signal higher than 1 KHZ
60V	0.01V	
600V	0.1V	
1000V	1V	

(15) AC Current + LPF

Range	Resolution	Remark
600A	0.1A	Intercept AC voltage signal higher than 1 KHZ
2500A	1A	

X. MAINTENANCE AND UPKEEP

1. General maintenance

Warning: to prevent electric shocking, it is required to keep the test pen away prior to opening the base cap.

- a. The clamp ammeter should be maintained and serviced by qualified professional serviceman or designated maintenance department.
- b. Clean the outer case with cloth, it is forbidden to clean with cleaning agent containing abrasive material or solvent.

2. Installation or replacement of battery

6LF22 9V battery, see Figure 14, will provide power for the clamp ammeter. Please install or replace battery as follows:

- a. Shut down the clamp ammeter, move away the test pen located at the input terminal.
- b. Put the panel facing down, screw out the battery box screws, take off battery cap and take out battery, install new battery as per the indication of polarity.
- c. It is required to install batteries of the same model. Do not install the improper battery.
- D. After installing new battery, load the battery cap and screw on screws.

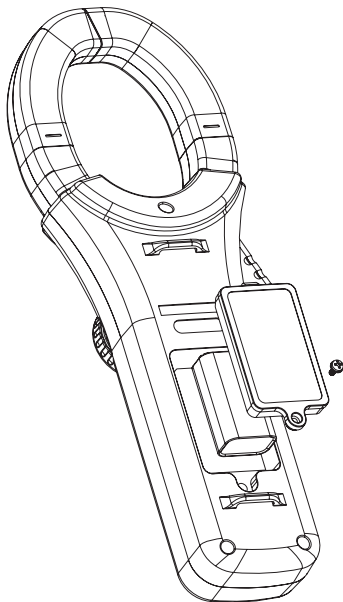

Manufacturer:
Uni-Trend Technology (China) Limited
No 6, Gong Ye Bei 1st Road
Songshan Lake National High-Tech Industrial
Development Zone, Dongguan City
Guangdong Province
China
Postal Code: 523 808

Headquarters:
Uni-Trend Group Limited
Rm901, 9/F, Nanyang Plaza
57 Hung To Road
Kwun Tong
Kowloon, Hong Kong
Tel: (852) 2950 9168
Fax: (852) 2950 9303
Email: info@uni-trend.com
<http://www.uni-trend.com>