

Table of Contents

Title	Page
Overview	p. 2
Unpacking Inspection	p. 3
Safety Information	p. 4
Rules For Safe Operation	p. 5~6
International Electrical Symbols	p. 6
The Meter Structure	p. 7
Rotary Switch	p. 8
Functional Buttons	p. 9~10
Display Symbols	p. 11~12
Measurement Operation	p. 13~22
A. DC Voltage Measurement	p. 13
B. AC Voltage Measurement	p. 14
C. Measuring Resistance	p. 15
D. Testing for Continuity	p. 16
E. Testing Diodes	p. 17
F. Capacitance Measurement	p. 18
G. Frequency Measurement	p. 19
H. Measuring Duty Cycle	p. 20
I. Temperature Measurement (Model UT206)	p. 21
J. AC Current Measurement	p. 22
Operation of Hold Mode	p. 23
The Use of Relative Value Mode	p. 23
The BLUE Button	p. 24
Turning on the Display Backlight	p. 24
Sleep Mode	p. 24
General Specifications	p. 25
Accuracy Specifications	p. 26~28
A. DC Voltage	p. 26
B. AC Voltage	p. 26
C. Resistance	p. 26
D. Continuity Test	p. 27
E. Diode Test	p. 27
F. Capacitance	p. 27
G. Frequency & Duty Cycle	p. 28
H. Temperature (Model UT206)	p. 28
I. AC Current	p. 28
Maintenance	p. 29
A. General Service	p. 29
B. Replacing the Battery	p. 29

Overview

This Operating Manual covers information on safety and cautions. Please read the relevant information carefully and observe all the **Warnings** and **Notes** strictly.

 **Warning**

To avoid electric shock or personal injury, read the “Safety Information” and “Rules for Safety Operation” carefully before using the Meter.

The **Model UT205** and **UT206** (hereafter referred to as “the Meter”) are 4000 counts, 3 3/4 digits hand-held digital auto ranging clamp multimeters with stabilize functions, safety operations, and reliable performance.

In addition to the conventional measuring functions, there is a unique jaw opening light and display backlight features enabling user to work in a dim condition. This is also a highly applied digital clamp multimeter of good performance with full overload protection and sleep mode. The Model UT206 also has temperature measurement function. Model

Except where noted, the descriptions and instructions in this Operating Manual apply to both the **Model UT205/UT206**.

Unpacking Inspection

Open the package case and take out the Meter. Check the following items carefully to see any missing or damaged part:

Item	Description	Qty
1	Operating Manual	1 piece
2	Test Lead	1 pair
3	Test Clip	1 pair
4	Model UT206: Point Contact Temperature Probe	1 piece
5	9V Battery (NEDA 1604, 6F22 or 0006P) (installed)	1 piece
6	1.5V Battery (AAA) (installed)	1 piece
7	Vinyl Bag	1 piece

In the event you find any missing or damage, please contact your dealer immediately.

Safety Information

This Meter complies with the standards IEC61010: in pollution degree 2, overvoltage category (CAT. II 1000V, CAT. III 600V) and double insulation.

CAT II: Local level, appliance, PORTABLE EQUIPMENT etc., with smaller transient voltage overvoltages than CAT. III

CAT III: Distribution level, fixed installation, with smaller transient overvoltages than CAT. IV

Use the Meter only as specified in this operating manual, otherwise the protection provided by the Meter may be impaired.

In this manual, a **Warning** identifies conditions and actions that pose hazards to the user, or may damage the Meter or the equipment under test.

A **Note** identifies the information that user should pay attention on.

International electrical symbols used on the Meter and in this Operating Manual are explained on page 6.

Rules For Safe Operation (1)

Warning













To avoid possible electric shock or personal injury, and to avoid possible damage to the Meter or to the equipment under test, adhere to the following rules:

- Never measure current while the test leads are inserted into the input terminals.
- Before using the Meter inspect the case. Do not use the Meter if it is damaged or the case (or part of the case) is removed. Look for cracks or missing plastic. Pay attention to the insulation around the connectors.
- Inspect the test leads for damaged insulation or exposed metal. Check the test leads for continuity. Replace damaged test leads with identical model number or electrical specifications before using the Meter.
- Do not apply more than the rated voltage, as marked on the Meter, between the terminals or between any terminal and grounding.
- The rotary switch should be placed in the right position and no any changeover of range shall be made during measurement is conducted to prevent damage of the Meter.
- When the Meter working at an effective voltage over 60V in DC or 30V rms in AC, special care should be taken for there is danger of electric shock.
- Use the proper terminals, function, and range for your measurements.
- Do not use or store the Meter in an environment of high temperature, humidity, explosive, inflammable and strong magnetic field. The performance of the Meter may deteriorate after dampened.
- When using the test leads, keep your fingers behind the finger guards.
- Disconnect circuit power and discharge all high-voltage capacitors before testing resistance, continuity, diodes, or capacitance.

Rules For Safe Operation (2)

- Replace the battery as soon as the battery indicator  appears. With a low battery, the Meter might produce false readings that can lead to electric shock and personal injury.
- Remove test leads, temperature probe and test clip from the Meter and turn the Meter power off before opening the Meter case.
- When servicing the Meter, use only the same model number or identical electrical specifications replacement parts.
- The internal circuit of the Meter shall not be altered at will to avoid damage of the Meter and any accident.
- Soft cloth and mild detergent should be used to clean the surface of the Meter when servicing. No abrasive and solvent should be used to prevent the surface of the Meter from corrosion, damage and accident.
- The Meter is suitable for indoor use.

International Electrical Symbols

	AC (Alternating Current)
	DC (Direct Current)
	AC or DC
	Deficiency of Built-In Battery
	Continuity Test
	Diode
	Grounding
	Capacitance Test
	Double Insulated
	Fuse
	Warning. Refer to the Operating Manual
	Conforms to Standards of European Union

The Meter Structure

(See figure 1)

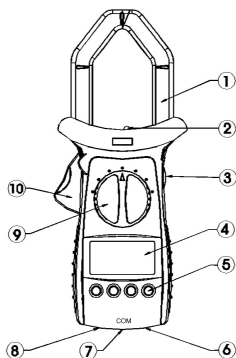













FIG 1

- ① Transformer Jaws designed to pick up the AC current flowing through the conductor.
- ② The Jaw Opening Light.
- ③ **HOLD** button.
- ④ LCD Display.
- ⑤ Function Button.
- ⑥ **V** Input Terminal:
Input for voltage measurement.
- ⑦ **COM** Input Terminal:
Return terminal for all measurements.
- ⑧ **HzΩ**:
Model UT205: Input for capacitance, continuity, diode, frequency/duty cycle and resistance measurements.
Model UT206: Input for capacitance, continuity, diode, frequency/duty cycle, resistance and temperature measurements.
- ⑨ Rotary Switch.
- ⑩ Trigger. Press the lever to open the transformer jaws and turn the jaw opening light on. When the pressure on the lever is released, the jaws will close and the light will off again.





Rotary Switch

Below table indicated for information about the rotary switch positions.





Rotary Switch Position	Function
OFF	Turn on or off the Meter.
V 	AC voltage measurement range from 4.000V to 600.0V or DC voltage measurement range from 400.0mV to 600.0V
V 	Model UT206: DC voltage measurement range from 400.0mV to 600.0V
V 	Model UT206: AC voltage measurement range from 4.000V to 600.0V
   	 Continuity test
	 Resistance measurement range from 400.0Ω to 40.00MΩ
	 Diode test
	 Capacitance test range from 4.000nF to 200.0μF
°C	Model UT206: Temperature in celsius from -40°C ~ 1000°C
Hz	Frequency measurement range from 10.00Hz to 10.00MHz
1000A 	AC current measurement range 400.0A to 1000A

Functional Buttons (1)

Below table indicated for information about the functional button operations.

Button	Measuring Function	Operation Performed
 (Yellow)	Any rotary switch position	Turn the display backlight on and off.
Hz	Hz	<ol style="list-style-type: none"> 1. Press to start the frequency counter; the Meter beeps. 2. Press again to enter duty cycle mode; the Meter beeps. 3. Press again to return to the frequency counter mode; the Meter beeps.
	$V \sim$, $V \sim$, $V \dots$ or 1000A \sim	<ol style="list-style-type: none"> 1. Press to start the frequency counter, the range is between 1Hz ~1kHz; the Meter beeps. 2. Press again to enter duty cycle mode; the Meter beeps. 3. Press again to return voltage or current mode; the Meter beeps.
REL 	Any rotary switch position except Hz , 	Press REL  to enter and exit the REL mode in any measuring mode except in frequency/duty cycle, diode and continuity; the Meter beeps.

Functional Buttons (2)

Button	Measuring Function	Operation Performed
 (Blue)		Switches between DC and AC voltage; the Meter beeps. DC voltage is default.
		Model UT205: Switches between diode and continuity measurements; the Meter beeps. Diode is default.
		Model UT206: Switches between resistance and diode and continuity and capacitance measurements; the Meter beeps. Resistance is default.
HOLD	Any rotary switch position	Press HOLD to enter and exit the Hold mode in any mode, the Meter beeps.

Display Symbols (1)

(See figure 2)

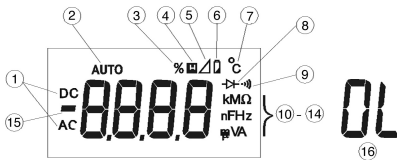







FIG 2

Number	Symbol	Meaning
①	AC	Indicator for AC voltage or current. The displayed value is the mean value.
	DC	Indicator for DC voltage. The displayed value is the mean value.
②	AUTO	The Meter is in the auto range mode in which the Meter automatically selects the range with the best resolution.
③	%	Percent: Used for duty cycle measurements.
④	H	Data hold is active.
⑤	△	The relative value mode is on to display the stored value minus the present
⑥	 	The battery is low. Warning To avoid false readings, which could lead to possible electric shock or personal injury, replace the battery as soon as the battery indicator appears.
⑦	°C	Centigrade. The unit of temperature.
⑧		Test of diode Model UT205/UT206:
⑨		The continuity buzzer is on.

Display Symbols (2)

(See figure 2)

Number	Symbol	Meaning
⑩-⑭	Ω, kΩ, MΩ	Ω: Ohm. The unit of resistance. kΩ: kilohm. 1×10^3 or 1000 ohms. MΩ: Megaohm. 1×10^6 or 1,000,000 ohms.
	F, μF, nF	F: Farad. The unit of capacitance. μF: Microfarad. 1×10^{-6} or 0.000001 farads. nF: Nanofarad. 1×10^{-9} or 0.000000001 farads.
	Hz, kHz, Mhz	Hz: Hertz. The unit of frequency. kHz: Kilohertz. 1×10^3 or 1000 hertz. MHz: Megahertz. 1×10^6 or 1,000,000 hertz.
	V, mV	V: Volts. The unit of voltage. mV: Millivolt. 1×10^{-3} or 0.001 volts.
	A, mA, μA	A: Amperes (amps). The unit of current. mA: Milliamp. 1×10^{-3} or 0.001 amperes. μA: Microamp. 1×10^{-6} or 0.000001 amperes.
⑮		Indicates negative reading.
⑯	OL	The input value is too large for the selected range.

Measurement Operation (1)

A. DC Voltage Measurement (See figure 3)

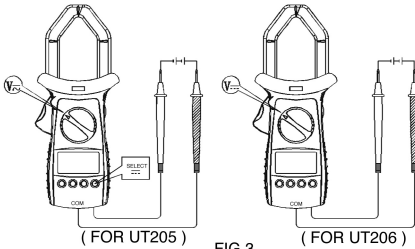

FIG 3



Warning

To avoid harms to you or damages to the Meter from electric shock, please do not attempt to measure voltages higher than 600V / 600V rms although readings may be obtained.

The DC Voltage ranges are: 400.0mV, 4.000V, 40.00V, 400.0V and 600.0V. To measure DC voltage, connect the Meter as follows:

1. Insert the red test lead into the **V** terminal and the black test lead into the **COM** terminal.
2. **Model UT205:** Set the rotary switch to **V⎓** ; DC measurement is default or press **BLUE** button to select DC measurement mode.
Model UT206: Set the rotary switch to **V⎓**
3. Connect the test leads across with the object being measured.
The measured value shows on the display.

Note

- In each range, the Meter has an input impedance of 10M . This loading effect can cause measurement errors in high impedance circuits. If the circuit impedance is less than or equal to 10k , the error is negligible (0.1% or less).
- When DC voltage measurement has been completed, disconnect the connection between the testing leads and the circuit under test, and remove the testing leads away from the input terminals of the Meter.

Measurement Operation (2)

B. AC Voltage Measurement (See figure 4)

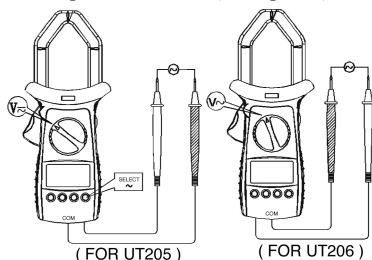

FIG 4

⚠ Warning

To avoid harms to you or damages to the Meter from electric shock, please do not attempt to measure voltages higher than 600V / 600V rms although readings may be obtained.

The AC voltage ranges are: 4.000V, 40.00V, 400.0V and 600.0V. To measure AC Voltage, connect the Meter as follows:

1. Insert the red test lead into the **V** terminal and the black test lead into the **COM** terminal.
2. **Model UT205:** Set the rotary switch to **V~** and press **BLUE** button to select AC measurement mode.
Model UT206: Set the rotary switch to **V~**.
3. Connect the test leads across with the object being measured. The measured value shows on the display.

Note

- In each range, the Meter has an input impedance of 10M . This loading effect can cause measurement errors in high impedance circuits. If the circuit impedance is less than or equal to 10k , the error is negligible (0.1% or less).
- When AC voltage measurement has been completed, disconnect the connection between the testing leads and the circuit under test, and remove the testing leads away from the input terminals of the Meter.
- Root mean square value stability period:
When the reading obtained is less than 100 digits, the root mean square value converter needs a longer time to stabilize. When there is no input voltage, the maximum reading displayed is 10 digits.

Measurement Operation (3)

C. Measuring Resistance (See figure 5)

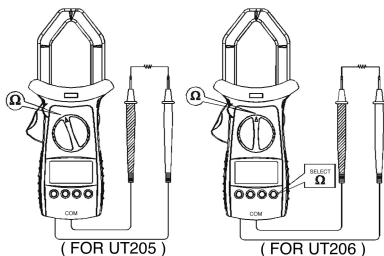

FIG 5

⚠ Warning

To avoid damages to the Meter or to the devices under test, disconnect circuit power and discharge all the high-voltage capacitors before measuring resistance.

The resistance ranges are: 400.0 Ω , 4.000k Ω , 40.00k Ω , 400.0k Ω , 4.000M Ω and 40.00M Ω . To measure resistance, connect the Meter as follows:

1. Insert the red test lead into the Ω terminal and the black test lead into the **COM** terminal.
2. **Model UT205:** Set the rotary switch to Ω .
Model UT206: Set the rotary switch to Ω , resistance measurement (Ω) is default or press **BLUE** button to select Ω measurement mode.
3. Connect the test leads across with the object being measured. The measured value shows on the display.

Note

- The test leads can add 0.1 Ω to 0.2 Ω of error to resistance measurement. To obtain precision readings in low-resistance measurement, that is the range of 400.0 Ω , short-circuit the input terminals beforehand, using the relative measurement function button **REL** to automatically subtract the value measured when the testing leads are short-circuited from the reading.
- If Ω reading with shorted test leads is not $\leq 0.5\Omega$, check for loose test leads, incorrect function selection, or enabled Data Hold function.
- For high-resistance measurement ($>1M\Omega$), it is normal to take several seconds to obtain a stable reading.
- The LCD displays **OL** indicating open-circuit for the tested resistor or the resistor value is higher than the maximum range of the Meter.

Measurement Operation (4)

- When resistance measurement has been completed, disconnect the connection between the testing leads and the circuit under test, and remove the testing leads away from the input terminals of the Meter.

D. Testing for Continuity (See figure 6)

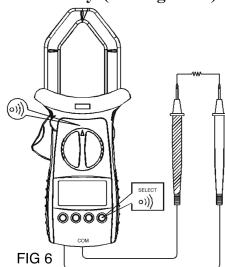

⚠ Warning

To avoid damages to the Meter or to the devices under test, disconnect circuit power and discharge all the high-voltage capacitors before testing for continuity.

To test for continuity, connect the Meter as below:

1. Insert the red test lead into the **HzΩ** terminal and the black test lead into the **COM** terminal.
2. **Model UT205:** Set the rotary switch to **HzΩ** and press **BLUE** button to select **HzΩ** measurement mode.
Model UT206: Set the rotary switch to **Ω** and press **BLUE** button to select **Ω** measurement mode.
3. The buzzer sounds if the resistance of a circuit under test is less than around 70Ω.

Note

- The LCD displays **OL** indicating the circuit being tested is open.
- When continuity testing has been completed, disconnect the connection between the testing leads and the circuit under test, and remove the testing leads away from the input terminals of the Meter.

Measurement Operation (5)

E. Testing Diodes (See figure 7)

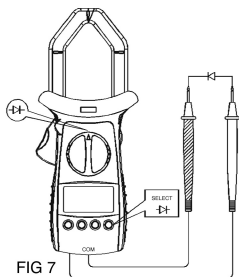

FIG 7

Warning

To avoid possible damage to the Meter and to the device under test, disconnect circuit power and discharge all high-voltage capacitors before testing diodes.

Use the diode test to check diodes, transistors, and other semiconductor devices. The diode test sends a current through the semiconductor junction, and then measures the voltage drop across the junction. A good silicon junction drops between 0.5V and 0.8V.

To test a diode out of a circuit, connect the Meter as follows:

1. Insert the red test lead into the $\text{Hz}\Omega$ terminal and the black test lead into the **COM** terminal.
2. **Model UT205:** Set the rotary switch to diode symbol , diode measurement (diode symbol) is default or press **BLUE** button to select diode symbol measurement mode.
Model UT206: Set the rotary switch to diode symbol and press **BLUE** button to select diode symbol measurement mode.
3. For forward voltage drop readings on any semiconductor component, place the red test lead on the component's anode and place the black test lead on the component's cathode.
The measured value shows on the display.

Note

- In a circuit, a good diode should still produce a forward voltage drop reading of 0.5V to 0.8V; however, the reverse-voltage drop reading can vary depending on the resistance of other pathways between the probe tips.
- Connect the test leads to the proper terminals as said above to avoid error display. The LCD will display **OL** indicating diode being tested is open or polarity is reversed. The unit of diode is Volt (V), displaying the forward voltage drop readings.

Measurement Operation (6)

- When diode testing has been completed, disconnect the connection between the testing leads and the circuit under test, and remove the testing leads away from the input terminals of the Meter.

F. Capacitance Measurement (See figure 8)

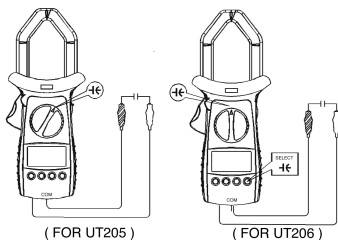

FIG 8

Warning

To avoid damage to the Meter or to the equipment under test, disconnect circuit power and discharge all high-voltage capacitors before measuring capacitance. Use the DC Voltage function to confirm that the capacitor is discharged.

The Meter's capacitance ranges are: 4.000nF, 40.00nF, 400.0nF, 4.000 μ F, 40.00 μ F, and 200.0 μ F. To measure capacitance, connect the Meter as follows:

- Insert the red test lead into the $\text{Hz}\Omega$ terminal and the black test lead into the COM terminal.
- Model UT205:** Set the rotary switch to f .
Model UT206: Set the rotary switch to f and press BLUE button to select f measurement mode.
- Connect the test leads across with the object being measured.
The measured value shows on the display.

Note

- For testing the capacitor with polarity, connect the red clip to anode & black clip to cathode instead of test leads as mentioned above.
- To minimize the effect of capacitance stored in the test leads, the test lead should be as short as possible. To measure a small value of capacitor, use REL mode to remove the test leads capacitance. Remaining voltage, insulated impedance, & dielectric absorption from the capacitor may cause the measurement error.
- It takes a longer time when testing a high capacitor value. The testing time is around 30 seconds in 200 μ F range.

Measurement Operation (7)

- The LCD displays **OL** indicating the tested capacitor is shorted or it exceeds the maximum range.
- When capacitance measurement has been completed, disconnect the connection between the testing leads and the circuit under test and remove the testing leads away from the input terminals of the Meter.

G. Frequency Measurement (See figure 9)

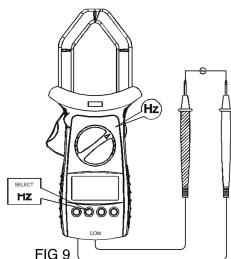

FIG 9

The measurement range is from 10Hz, 100Hz, 1kHz, 10kHz, 100kHz, 1MHz and 10MHz. To measure frequency, connect the Meter as follows:

1. Insert the red test lead into the **HzΩ** terminal and the black test lead into the **COM** terminal.
2. Set the rotary switch to **Hz**; frequency measurement (Hz) is default or press **Hz** button to select Hz measurement mode.
3. Connect the test leads across with the object being measured.
The measured value shows on the display.

Note

- When frequency measurement has been completed, disconnect the connection between the testing leads and the circuit under test, and remove the testing leads away from the input terminals of the Meter.
- When making frequency measurement at voltage or current range, please mind the following signal requirement table:

Range	Signal Requirement	Frequency Range
400mV	≥ 100mV	1Hz~1kHz
4V	≥ 0.45V	1Hz~1kHz
40V	≥ 4.5V	1Hz~1kHz
400V	≥ 45V	1Hz~1kHz
600V	≥ 450V	1Hz~200Hz
1000A	≥ 450A	45Hz~65Hz

Measurement Operation (8)

H. Measuring Duty Cycle (See figure 10)

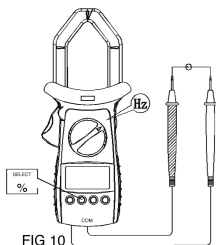

The duty cycle measurement range is: 0.1%~99.9%. To measure duty cycle, do the following:

1. Set up the Meter to measure frequency.
2. To select duty cycle, press **Hz** until the % symbol is shown on the display.
3. Connect the test leads across with the object being measured.
The measured value shows on the display.

Note

- The LCD displays 000.0% indicating the input signal is high or low level.
- When duty cycle measurement has been completed, disconnect the connection between the testing leads and the circuit under test, and remove the testing leads away from the input terminals of the Meter.

Measurement Operation (9)

I. Model UT206: Temperature Measurement (See figure 11)

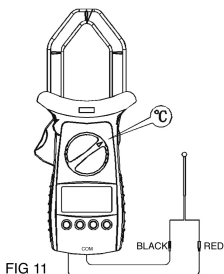

FIG 11

The temperature measurement range is $-40^{\circ}\text{C}\sim 1000^{\circ}\text{C}$. To measure temperature, connect the Meter as follows:

1. Insert the red temperature probe into the $\text{Hz}\Omega$ terminal and the black temperature probe into the COM terminal.
2. Set the rotary switch to $^{\circ}\text{C}$.
3. Place the temperature probe to the object being measured.
The measured value shows on the display.

Note

- The Meter automatically displays the temperature value inside the Meter when there is no temperature probe connection.
- The included point contact temperature probe (Part no. 41700103) can only be used up to 250°C . For any measurement higher than that, the rod type temperature probe (Part no. 41700109) must be used instead.
- When temperature measurement has been completed, disconnect the connection between the testing leads and the circuit under test, and remove the testing leads away from the input terminals of the Meter.

Measurement Operation (10)

J. AC Current Measurement (See figure 12)

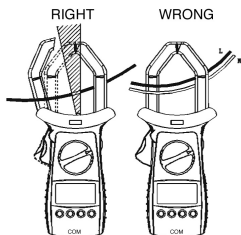

FIG 12

⚠ Warning

To avoid electric shock, never measure current while the test leads are inserted into the input terminals and disconnect test leads and tested circuit connection.

Never attempt an in-circuit current measurement where the open-circuit voltage between the circuit and ground is greater than 600V.

Use proper function, and range for the measurement.

The measurement ranges of current are: 400.0A and 1000A. To measure current, do the following:

1. Set the rotary switch to 1000A .
2. Press the lever to open the transformer jaws.
3. Center the conductor within the transformer jaw.

The measured value shows on the display, it is a effective value of sine wave (mean value response).

Note

- When current measurement has been completed, disconnect the connection between the conductor under test and the jaw, and remove the conductor away from the transformer jaw of the Meter.

Operation of Hold Mode

Warning

To avoid possibility of electric shock, do not use Hold mode to determine if circuits are without power. The Hold mode will not capture unstable or noisy readings.

The Hold mode is applicable to all measurement functions.





- Press **HOLD** to enter Hold mode; the Meter beeps.
- Press **HOLD** again or turn the rotary switch to exit Hold mode; the Meter beeps.
- In Hold mode, **H** is displayed.

The Use of Relative Value Mode

The REL mode applies to all measurement functions except frequency/duty cycle, diode and continuity measurement. It subtracts a stored value from the present measurement value and displays the result.

For instance, if the stored value is 20.0V and the present measurement value is 22.0V, the reading would be 2.0V. If a new measurement value is equal to the stored value then display 0.0V.

To enter or exit REL mode:

- Use rotary switch to select the measurement function before selecting **REL** . If measurement function changes manually after **REL**  is selected, the Meter exits the REL mode.
- Press **REL**  to enter REL mode, auto ranging turns off except under capacitance testing mode, and the present measurement range is locked and display 'O' as the stored value.
- Press **REL**  again or turn the rotary switch to reset the stored value and exit REL mode.

Pressing **HOLD** in REL mode makes the Meter stop updating. Pressing **HOLD** again to resume updating.

The BLUE button

It uses for selecting the required measurement function when there is more than one function at one position of the rotary switch.

Turning on the Display Backlight

Warning

In order to avoid the hazard arising from mistaken readings in insufficient light or poor vision, please use Display Backlight function.

- Press and hold **YELLOW** button for over 2 seconds to turn the Display Backlight on.
- Press **YELLOW** button again to turn the Display Backlight off, otherwise it will stay on continuously.



Sleep Mode

To preserve battery life, the Meter automatically turns off if you do not turn the rotary switch or press any button for around 15 minutes.

The Meter can be activated by turning the rotary switch or pressing the **YELLOW**, **Hz** or **REL**  button, it will display the present measurement value.

To disable the Sleep Mode function, press **BLUE** button while turning on the Meter.

General Specifications

- Max. Voltage 600V rms.
 between any Terminals
 and Grounding:
- Max. Current 1000A AC rms continuous.
 Measurement of
 Transformer Jaw:
- Max. Jaw Size: 40mm conductor.
- Max. Display: Digital: 3999
- Measurement Speed: Updates 3 times/second.
- Temperature: Operating: 5°C to +35°C
 (41°F to +95°F).
 Storage: -10°C to +50°C
 (14°F to +122°F).
- Relative Humidity: ≤75% @ 0 - 30°C ;
 ≤50% @ 31°C - 40°C.
- Altitude: Operating: 2000 m.
 Storage: 10000 m.
- Battery Type: The Meter: One piece of 9V
 (NEDA1604 or 6F22 or 006P).
 The Jaw Opening Light:
 One piece of 1.5V (AAA)
- Battery Deficiency: Display 
- Dimensions (HxWxL): 260 x 104 x 52 mm.
- Weight: Approximate 530g
 (battery included).
- Safety/Compliances: IEC61010 CAT. II 1000V,
 CAT. III 600V overvoltage and
 double insulation standard.
- Certifications: , UL pending.

Accuracy Specifications (1)

Accuracy: \pm (a% reading + b digits), guarantee for 1 year.

Operating temperature $23^{\circ}\text{C}\pm 5^{\circ}\text{C}$.

Relative humidity $<75\%$.

Temperature coefficient: $0.1 \times$ (specified accuracy) / 1°C .

A. DC Voltage

Range	Resolution	Accuracy	Overload Protection
400mV	100 μ V	$\pm(0.8\%+3)$	600V DC 600V AC rms continuous.
4V	1mV	$\pm(0.8\%+1)$	
40V	10mV		
400V	100mV		
600V	1V	$\pm(1\%+3)$	

Remarks: Input impedance $\geq 10\text{M}\Omega$.

B. AC Voltage

Range	Resolution	Accuracy	Overload Protection
4V	1mV	$\pm(1.2\%+5)$	600V DC 600V AC rms continuous
40V	10mV		
400V	100mV		
600V	1V	$\pm(1.5\%+5)$	

Remarks:

- Input impedance $\geq 10\text{M}\Omega$.
- Displays effective value of sine wave (mean value response).
- Frequency response:
When $<400\text{V}$: 40Hz~400Hz;
When $\geq 400\text{V}$: 40Hz~100Hz

C. Resistance

Range	Resolution	Accuracy	Overload Protection
400 Ω	0.1 Ω	$\pm(1.2\%+2)$	600Vp
4k Ω	1 Ω	$\pm(1\%+2)$	
40k Ω	10 Ω		
400k Ω	100 Ω		
4M Ω	1k Ω	$\pm(1.2\%+2)$	
40M Ω	10k Ω	$\pm(1.5\%+2)$	

Remarks: Open circuit voltage approximate 0.45V.

Accuracy Specifications (2)

D. Continuity Test

Range	Resolution	Accuracy	Overload Protection
400.0Ω	0.1Ω	Approximate <70Ω	600Vp

Remarks:

- Buzzer beeps continuous.
- Open circuit voltage approximate 0.45V.

E. Diode Test

Range	Resolution	Overload Protection
Diode	1mV	600Vp

Remarks:

- Open circuit voltage approximate 1.48V.
- Displays approximate forward voltage drop: 0.5V~0.8V.

F. Capacitance

Range	Resolution	Accuracy	Overload Protection
4nF	1pF	Measure at REL mode $\pm(5\%+40)$	600Vp
40nF	10pF	$\pm(3\%+5)$	
400nF	100pF		
4μF	1nF		
40μF	10nF		
200μF	100nF	$\pm(4\%+10)$	

Remarks:

- **40nF~200μF:**
Reading < 1nF is only for reference purpose.

Accuracy Specifications (3)

G. Frequency & Duty Cycle

Range	Resolution	Accuracy	Overload Protection
10Hz	0.001Hz	±(0.1%+3)	600Vp
100Hz	0.01Hz		
1kHz	0.1Hz		
10kHz	1Hz		
100kHz	10Hz		
1MHz	100Hz		
10MHz	1Hz		
0.1% ~99.9%	0.01%		

Remarks:

- **10Hz~10MHz Range:**

Input sensitivity as follows:

≤1MHz: ≤300mV rms;

>1MHz: ≤600mV rms.

- **0.1% ~ 99.9%:**

Reading is only for reference purpose.

H. Temperature (Model UT206)

Range	Resolution	Accuracy	
-40°C~1000°C	1°C	-40°C~0°C	±(3%+4)
		0°C~400°C	±(1%+3)
		400°C~1000°C	±(2%+10)

Input Protection: 600Vp

I. AC Current

Range	Resolution	Accuracy	Overload Protection
400A	0.1A	±(1.5%+5)	1000A AC rms continuous
1000A	1A	≤800A: ±(2%+5)	
		>800A: ±(3%+5)	

Remarks:

- Frequency response 50Hz~60Hz.
- Display effective value of sine wave (mean value response)

MAINTENANCE

This section provides basic maintenance information including battery replacement instruction.

Warning

Do not attempt to repair or service your Meter unless you are qualified to do so and have the relevant calibration, performance test, and service information.

To avoid electrical shock or damage to the Meter, do you get water inside the case.

A. General Service

- Periodically wipe the case with a damp cloth and mild detergent. Do not use abrasives or solvents.
- To clean the terminals with cotton bar with detergent, as dirt or moisture in the terminals can affect readings.
- Turn the Meter to **OFF** position when it is not in use.
- Take out the battery when it is not using for a long time.
- Do not use or store the Meter in a place of humidity, high temperature, explosive, inflammable and strong magnetic field.

B. Replacing the Battery

Warning

To avoid false readings, which could lead to possible electric shock or personal injury, replace the battery as soon as the battery indicator “” appears.

Make sure the transformer jaw and the test leads are disconnected from the circuit being tested before opening the case bottom.

Make sure the test leads are removed from the input terminals.

To replace the battery:

1. Turn the rotary switch of the Meter to **OFF** position and remove all the connections from the terminals.
2. Remove the screw from the battery compartment, and separate the battery compartment from the case bottom.
3. Remove the battery from the battery compartment.
4. Replace the battery with a new 9V battery (NEDA1604, 6F22 or 006P) and or a 1.5V battery (AAA).
5. Rejoin the case bottom and battery compartment, and reinstall the screw.

UNI-T®

Model UT205/206: OPERATING MANUAL

This operating manual is subject to change without notice.
© Copyright 2001 Uni-Trend International Limited.
All rights reserved.

UNI-T®

Model UT205/206: OPERATING MANUAL

UNI-T®

Model UT205/206: OPERATING MANUAL

Manufacturer: UNI-TREND TECHNOLOGY(DONG GUAN)LIMITED
Address: Dong Fang Da Dao, Bei Shan Dong Fang Industrial
Development District, Hu Men Town, Dong Guan City,
Guang Dong Province, China

Headquarters: Uni-Trend International Limited
Address: Rm901, 9/F, Nanyang Plaza 57 Hung To Road
Kwun Tong Kowloon, Hong Kong

Tel: (852) 2950 9168

Fax: (852) 2950 9303

Email: info@uni-trend.com

<http://www.uni-trend.com>